



Product designation

Product type designation

Mechanical features

Weight

g 58

Dimensions [mm (in)]

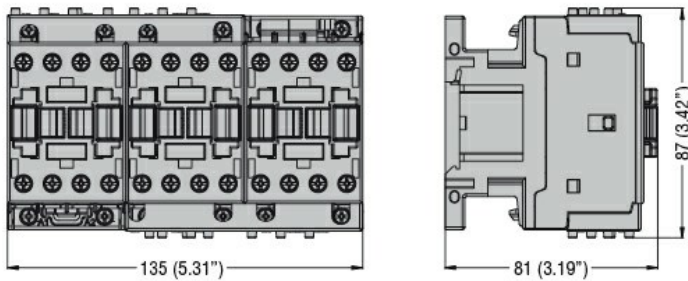

Rigid connecting kits for star-delta starter. For BF09...BF25 BFX3131

Wiring diagrams

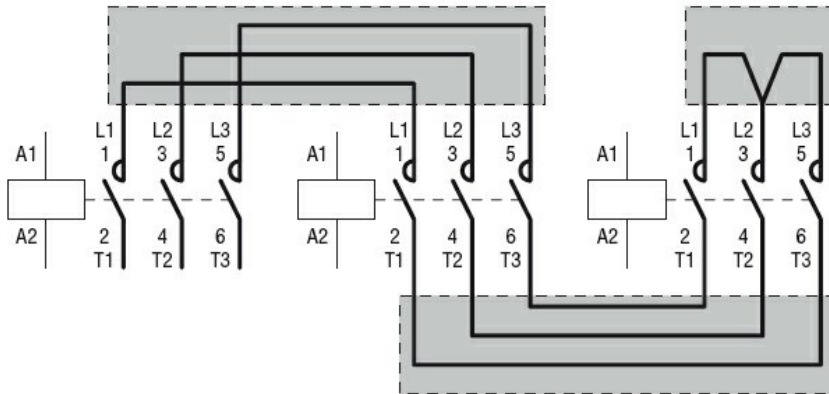

Certifications and compliance

Compliance

CSA C22.2 n° 60947-1
IEC/EN 60947-1
UL 60947-1

Certificates

cULus
EAC

ETIM classification

ETIM 8.0

EC002498 - Accessories/spare parts for low-voltage switch technology